

JVC

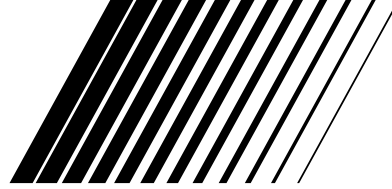

COMPACT COMPONENT SYSTEM

HX-GX7

—Consists of CA-HXGX7 and SP-HXGX7

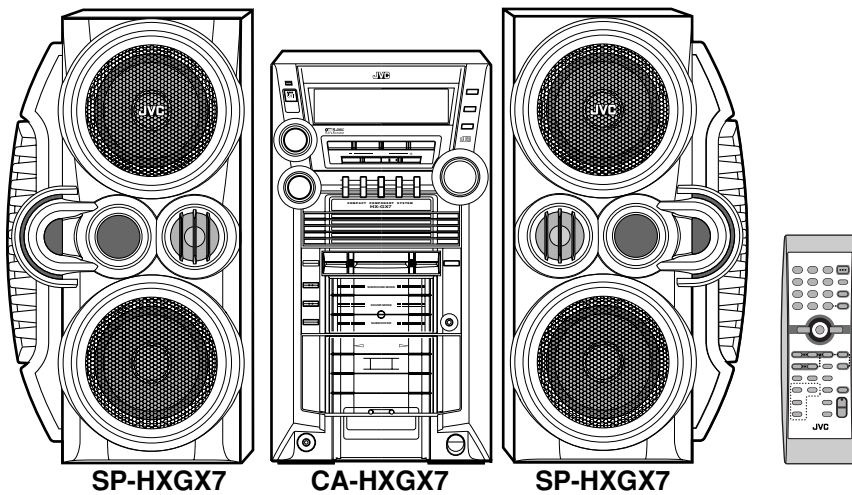

COMPACT
disc
DIGITAL AUDIO

INSTRUCTIONS

For Customer Use:

Enter below the Model No. and Serial No. which are located either on the rear, bottom or side of the cabinet. Retain this information for future reference.

Model No. _____

Serial No. _____

GVT0124-001A

[J]

Warnings, Cautions and Others

Mises en garde, précautions et indications diverses

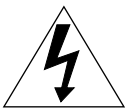
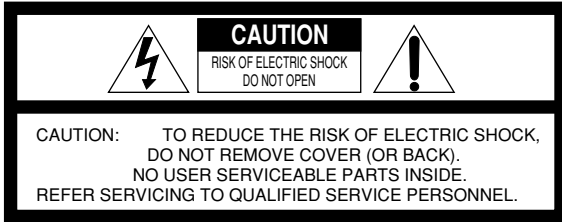

The lightning flash with arrowhead symbol, within an equilateral triangle is intended to alert the user to the presence of uninsulated "dangerous voltage" within the product's enclosure that may be of sufficient magnitude to constitute a risk of electric shock to persons.



The exclamation point within an equilateral triangle is intended to alert the user to the presence of important operating and maintenance (servicing) instructions in the literature accompanying the appliance.

WARNING: TO REDUCE THE RISK OF FIRE OR ELECTRIC SHOCK, DO NOT EXPOSE THIS APPLIANCE TO RAIN OR MOISTURE.

For U.S.A.

This equipment has been tested and found to comply with the limits for a Class B digital device, pursuant to part 15 of the FCC Rules. These limits are designed to provide reasonable protection against harmful interference in a residential installation.

This equipment generates, uses and can radiate radio frequency energy and, if not installed and used in accordance with the instructions, may cause harmful interference to radio communications. However, there is no guarantee that interference will not occur in a particular installation. If this equipment does cause harmful interference to radio or television reception, which can be determined by turning the equipment off and on, the user is encouraged to try to correct the interference by one or more of the following measures:

- Reorient or relocate the receiving antenna.
- Increase the separation between the equipment and receiver.
- Connect the equipment into an outlet on a circuit different from that to which the receiver is connected.
- Consult the dealer or an experienced radio/TV technician for help.

CAUTION

To reduce the risk of electrical shocks, fire, etc.:

- 1 Do not remove screws, covers or cabinet.
- 2 Do not expose this appliance to rain or moisture.

ATTENTION

Afin d'éviter tout risque d'électrocution, d'incendie, etc.:

- 1 Ne pas enlever les vis ni les panneaux et ne pas ouvrir le coffret de l'appareil.
- 2 Ne pas exposer l'appareil à la pluie ni à l'humidité.

Caution— ϕ /I (STANDBY/ON) button!

Disconnect the mains plug to shut the power off completely. The ϕ /I (STANDBY/ON) button in any position does not disconnect the mains line. The power can be remote controlled.

Attention— ϕ /I Commutateur (attente/sous tension)!

Déconnecter la fiche de secteur pour couper complètement le courant. Le commutateur ϕ /I (attente/sous tension) ne coupe jamais complètement la ligne de secteur, quelle que soit sa position. Le courant peut être télécommandé.

Note to CATV system installer:

This reminder is provided to call the CATV system installer's attention to Section 820-40 of the NEC which provides guidelines for proper grounding and, in particular, specifies that the cable ground shall be connected to the grounding system of the building, as close to the point of cable entry as practical.



CAUTION!

To avoid personal injury or accidentally dropping the unit, have two persons unpack, carry, and install the unit.

ATTENTION!

Pour éviter toute blessure personnelle ou chute accidentelle de l'appareil, faites déplacer, transporter et installer l'appareil par deux personnes.

For Canada/pour le Canada

CAUTION: TO PREVENT ELECTRIC SHOCK, MATCH WIDE BLADE OF PLUG TO WIDE SLOT, FULLY INSERT.

ATTENTION: POUR EVITER LES CHOCS ELECTRIQUES, INTRODUIRE LA LAME LA PLUS LARGE DE LA FICHE DANS LA BORNE CORRESPONDANTE DE LA PRISE ET POUSSER JUSQU'AU FOND.

For Canada/pour le Canada

THIS DIGITAL APPARATUS DOES NOT EXCEED THE CLASS B LIMITS FOR RADIO NOISE EMISSIONS FROM DIGITAL APPARATUS AS SET OUT IN THE INTERFERENCE-CAUSING EQUIPMENT STANDARD ENTITLED "DIGITAL APPARATUS," ICES-003 OF THE DEPARTMENT OF COMMUNICATIONS.

CET APPAREIL NUMERIQUE RESPECTE LES LIMITES DE BRUITS RADIOELECTRIQUES APPLICABLES AUX APPAREILS NUMERIQUES DE CLASSE B PRESCRITES DANS LA NORME SUR LE MATERIEL BROUILLEUR: "APPAREILS NUMERIQUES", NMB-003 EDICTEE PAR LE MINISTRE DES COMMUNICATIONS.

- 1 CLASS 1 LASER PRODUCT
- 2 **CAUTION:** Do not open the top cover. There are no user serviceable parts inside the Unit; leave all servicing to qualified service personnel.
- 3 **CAUTION:** Visible and invisible laser radiation when open and interlock failed or defeated. Avoid direct exposure to beam.
- 4 REPRRODUCTION OF LABEL: CAUTION LABEL, PLACED INSIDE UNIT.

- 1 PRODUIT LASER CLASSE 1
- 2 **ATTENTION:** N'ouvrez pas le couvercle supérieur. Il n'y a aucune pièce réparable par l'utilisateur à l'intérieur de l'appareil; confiez toute réparation à un personnel qualifié.
- 3 **ATTENTION:** Risque de radiations laser visible et invisible quand l'appareil est ouvert ou que le système de verrouillage ne fonctionne pas ou a été mis hors service. Évitez toute exposition directe au rayon.
- 4 REPRODUCTION DE L'ÉTIQUETTE: ÉTIQUETTE DE PRÉCAUTION PLACÉE L'INTERIEUR DE L'APPAREIL

CAUTION : Visible and invisible laser radiation when open and interlock failed or defeated. AVOID DIRECT EXPOSURE TO BEAM. (e)

WARNING : Synlig och osynlig laserstrålning när den öppnas och spärren är urkopplad. Beträkta ej strålen. (s)

ADVARSEL : Synlig og usynlig laserstrålning når maskinen er åben eller interlocken fejler. Undgå direkte eksponering til stråling. (d)

VARO : Avattaessa ja suojalukitus ohitettuna tai viallisena olet alltiina näkyvälle ja näkymättömälle lasersäteilylle. Vältä säteen kohdistumista suoraan itseesi. (f)

Contents

Introduction	2
Precautions	2
How to Read This Manual.....	2
Getting Started	3
Step 1: Unpack	3
Step 2: Prepare the Remote Control	3
Step 3: Hook Up	4
Before Operating the System	6
Parts Index	6
Daily Operations—Playback	8
Canceling the Demonstration	8
Listening to the Radio	9
Playing Back a Disc.....	10
Playing Back a Tape.....	11
Daily Operations—Sound&Other Adjustments	12
Adjusting the Volume.....	12
Reinforcing the Bass Sound	12
Selecting the Sound Modes	13
Creating Your Own Sound Modes—User Mode	13
Turning On or Off the Key-Touch Tone	14
Setting the Clock	14
Turning Off the Power Automatically.....	14
Advanced Disc Operations	15
Programming the Playing Order—Program Play	15
Playing at Random—Random Play	16
Repeating Playback—Repeat Play	17
Prohibiting Disc Ejection—Tray Lock.....	17
Advanced Tape Operations	18
Recording on a Tape.....	18
Synchronized Disc Recording	19
Timer Operations	20
Setting the Timer	20
Timer Priority	21
Additional Information	22
Learning More about This System	22
Maintenance	23
Troubleshooting.....	23
Specifications	24

Introduction

Precautions

Installation

- Install in a place which is level, dry and neither too hot nor too cold—between 5°C and 35°C.
- Install the System in a location with adequate ventilation to prevent internal heat buildup in the System.



DO NOT install the System in a location near heat sources, or in a place subject to direct sunlight, excessive dust or vibration.

- Leave sufficient distance between the System and the TV.
- Keep the speakers away from the TV to avoid interference with TV.

Power sources

- When unplugging the System from the wall outlet, always pull on the plug, not the AC power cord.



DO NOT handle the AC power cord with wet hands.

Moisture condensation

Moisture may condense on the lenses inside the System in the following cases:

- After starting to heat the room
- In a damp room
- If the System is brought directly from a cold to a warm place.

Should this occur, the System may malfunction. In this case, leave the System turned on for a few hours until the moisture evaporates, unplug the AC power cord, then plug it in again.

Internal heat

- A cooling fan is mounted on the rear panel to prevent heat buildup inside the unit.



For safety, observe the following carefully:

- Make sure there is good ventilation around the unit. Poor ventilation could overheat and damage the unit.
- DO NOT block the cooling fan and the ventilation openings or holes. If they are blocked by a newspaper or cloth, etc., the heat may not be able to get out.

Others

- Should any metallic object or liquid fall into the System, unplug the AC power cord and consult your dealer before operating any further.



DO NOT disassemble the System since there are no user serviceable parts inside.

- If you are not going to operate the System for an extended period of time, unplug the AC power cord from the wall outlet.

If anything goes wrong, unplug the AC power cord and consult your dealer.

How to Read This Manual

To make the explanations in this manual as simple and easy-to-understand as possible, we have adapted the following methods:

- Button and control operations are explained as listed in the table below.
- **Some related tips and notes are explained later in the sections “Learning More about This System” and “Troubleshooting,” but not in the same section explaining the operations.** If you want to know more about the functions, or if you have a doubt about the functions, go to these sections and you will find the answers.

	Indicates that you press the button briefly .
	Indicates that you press the button briefly and repeatedly until an option you want is selected.
	Indicates that you press one of the buttons.
	Indicate that you press and hold the button for an specified periods. <ul style="list-style-type: none"> • The number inside the arrow indicates the period of press (in this example, 2 seconds). • If no number is inside the arrow, press and hold until the entire procedure is complete or until you get a result you want.
	Indicate that you turn the control toward the specified direction(s).
	Indicates that this operation is only possible using the remote control.
	Indicates that this operation is only possible using the buttons and controls on the Main unit.

Getting Started

Step 1: Unpack the package and check the accessories.



Step 1: Unpack

After unpacking, check to be sure that you have all the following items. The number in parentheses indicates the quantity of each piece supplied.

- FM antenna (1)
- AM loop antenna (1)
- Remote control (1)
- Batteries (2)

If any item is missing, consult your dealer immediately.

Step 2: Prepare the Remote Control

Insert the batteries into the remote control by matching the polarity (+ and -) correctly.

Step 2: Prepare the remote control.

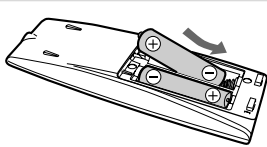

1

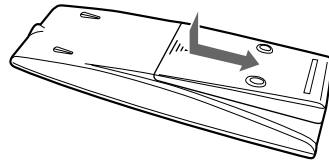

2

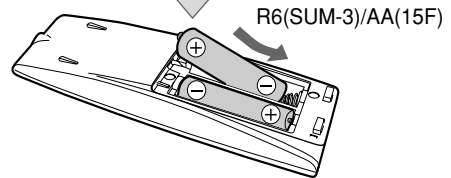

3

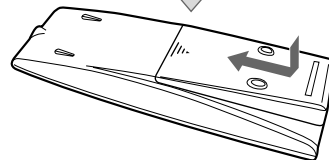

Step 3: Hook up the components such as AM/FM antennas, the speakers, etc.

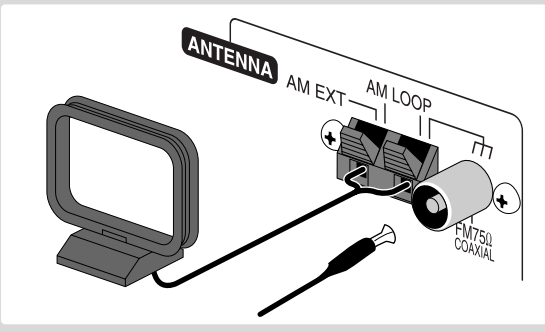

Finally plug the AC power cord.
Now you can operate this System.

- DO NOT use an old battery together with a new one.
- DO NOT use different types of batteries together.
- DO NOT expose batteries to heat or flame.
- DO NOT leave the batteries in the battery compartment when you are not going to use the remote control for an extended period of time. Otherwise, the remote control will be damaged from battery leakage.



Step 3: Hook Up

If you need more detailed information, see page 5.

Illustrations of the input/output terminals below are typical examples.

When you connect other components, refer also to their manuals since the terminal names actually printed on the rear vary among the components.

Turn the power off to all components before connections.

FM antenna (supplied)

Extend it so that you can obtain the best reception.

AM loop antenna (supplied)

Turn it until the best reception is obtained.

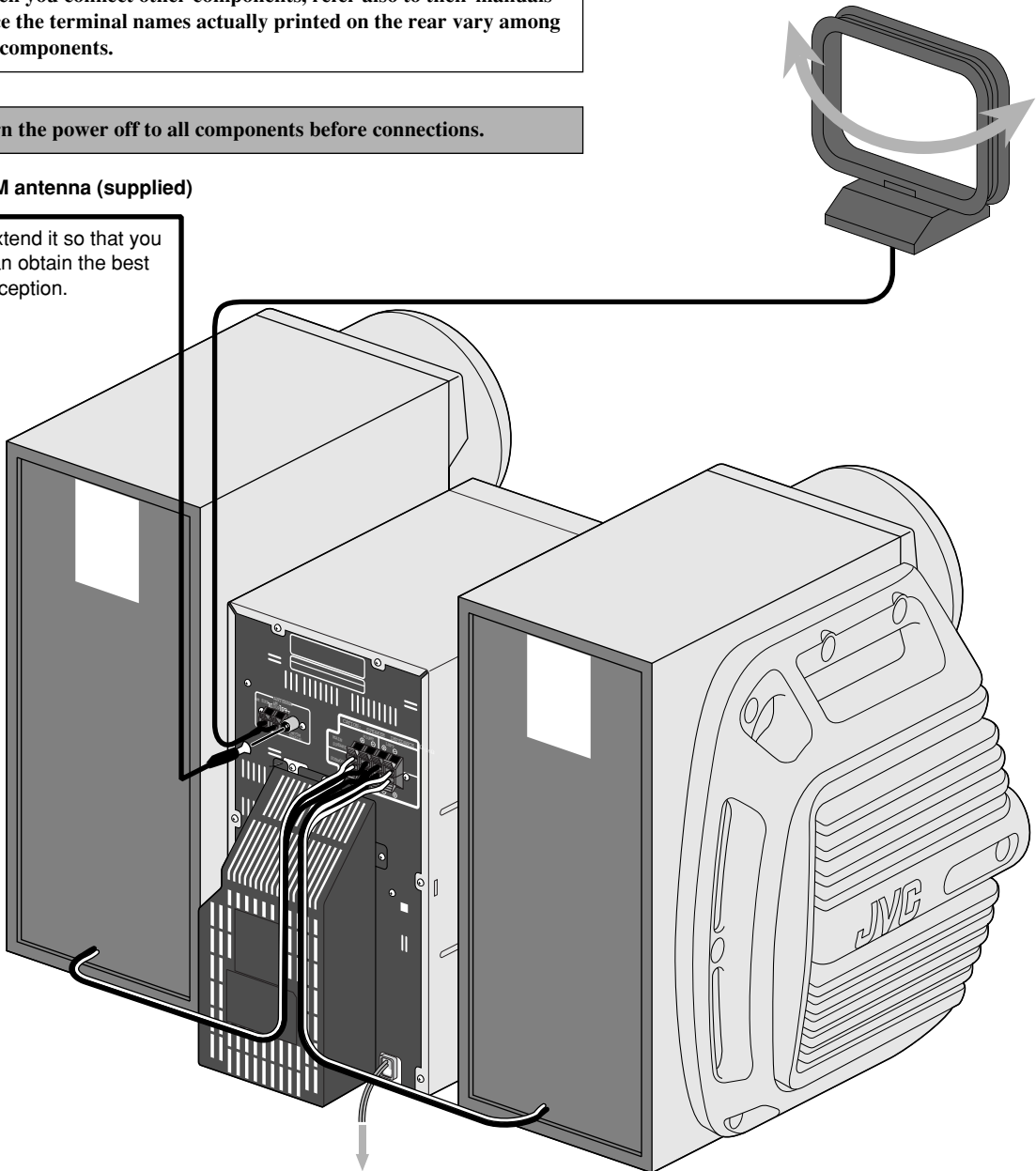

To a wall outlet

Plug the AC power cord only after all connections are complete.

- Demonstration will start automatically. To cancel it, see page 8.

To assemble and connect the AM loop antenna

To assemble the AM loop antenna

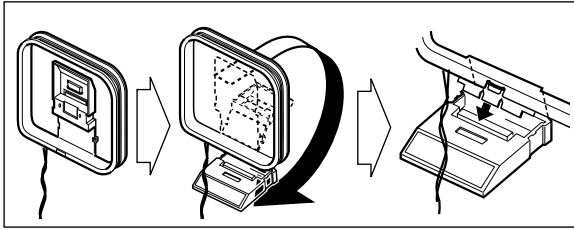

To connect the AM loop antenna cords

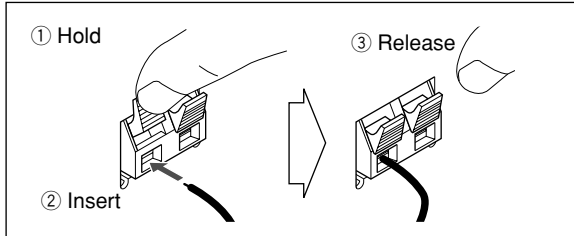

- If the AM loop antenna wire or speaker cords are covered with vinyl, remove the vinyl to expose the tip of the antenna by twisting the vinyl.
- Make sure the antenna conductors do not touch any other terminals, connecting cords and power cord. Also, keep the antennas away from metallic parts of the System, connecting cords, and the AC power cord. This could cause poor condition.

For better FM/AM reception

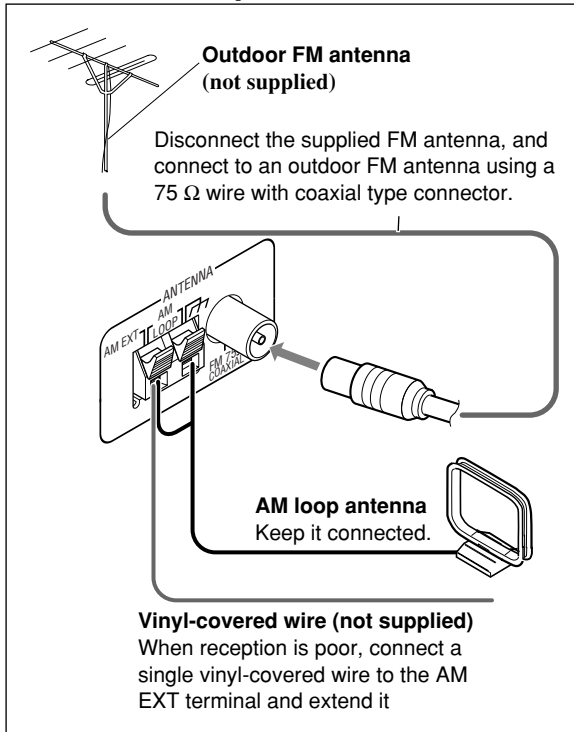

To connect the speaker cords

- When connecting the speaker cords, match the polarity of the speaker terminals: (+) to (+) and (-) to (-).
- Use only speakers with the same speaker impedance as indicated by the speaker terminals on the rear of the unit.



- DO NOT connect more than one speaker to each terminal.
- DO NOT push or pull the speakers as this will damage the foot spacers at the bottom of the speakers.

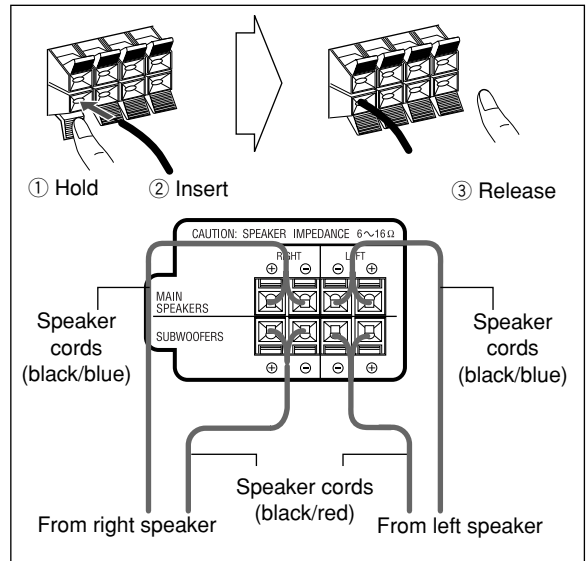

To Connect Other Equipment

By using a stereo mini plug cord (not supplied), you can connect equipment with analog audio output jacks such as an MD player, a TV, etc.

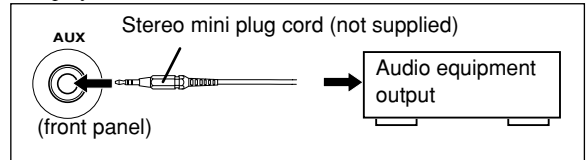

If the audio output on the other equipment is not stereo mini plug type, use a plug adapter to convert the stereo mini plug to the corresponding plug of the audio output.

IMPORTANT

- Always set volume to MIN when connecting or disconnecting the other equipment.



DO NOT plug in any equipment until all connections are complete.

Before Operating the System

Parts Index

Refer to the pages to see how to use the buttons and controls.

Remote control

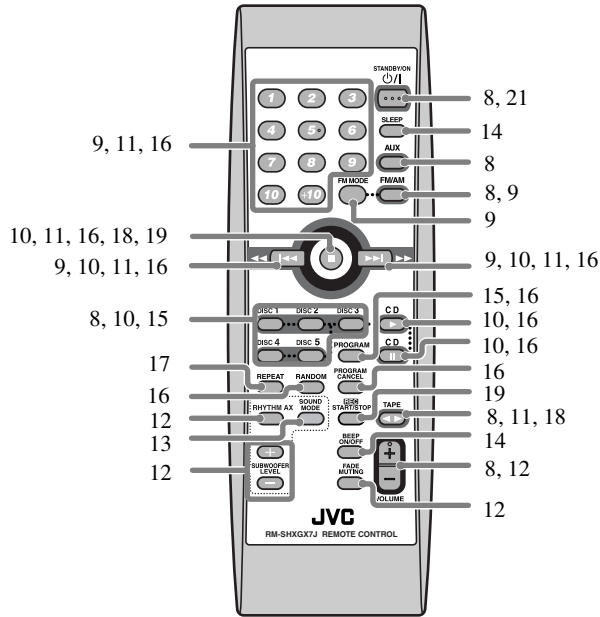

Main unit

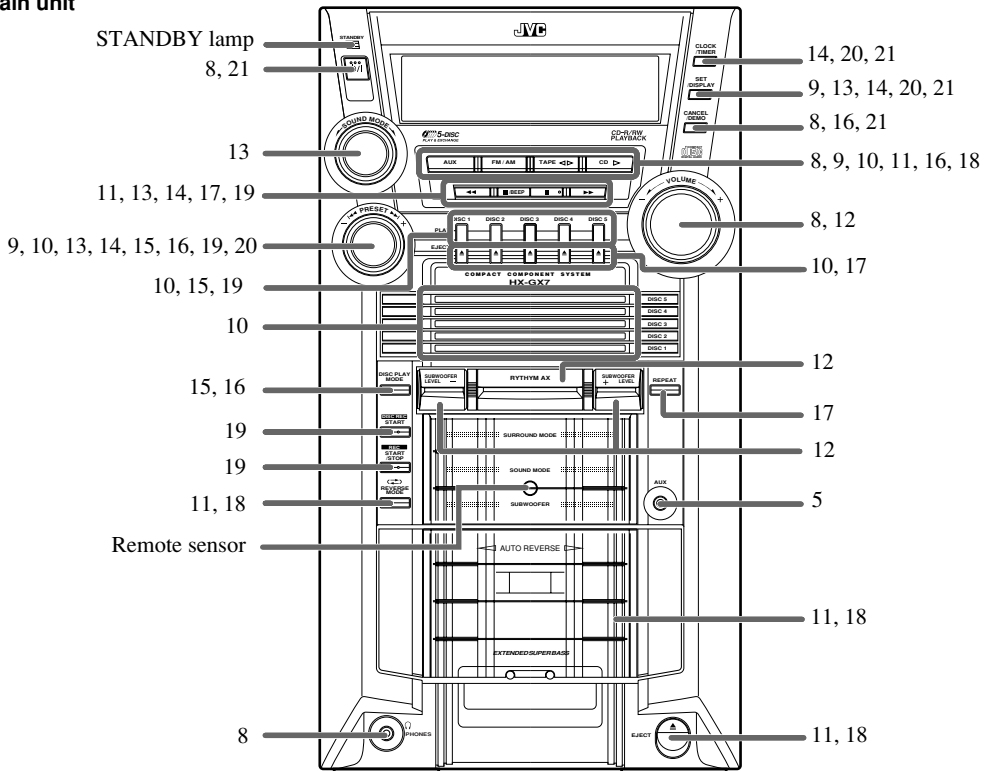

The indications on the display teach you a lot of things while you are operating the System. Before operating the System, be familiar with when and how the indicator illuminates on the display.

Display Window

Indications on the main display

- While listening to radio:
 - Band: FM
 - Reception mode (FM only): ST
 - Frequency: 88.3
- While playing a disc:
 - CD:**
 - Track number: 2
 - Elapsed playing time: 0:34
 - MP3:**
 - Group number: 2
 - Elapsed playing time: 2:41
 - Track number: 3
- While disc play is stopped:
 - CD:**
 - Total track number: 12
 - Total playing time: 50:44
 - MP3:**
 - Group number: 502
 - Track number: 1003
- While selecting "TAPE" or "AUX":
 - Source name: TAPE

* When the beginning of the MP3 track, the track title will be shown before the elapsed playing time appears.

- 1 BEEP ON indicator
 - Lights when key-touch tone is activated.
- 2 MP3 indicator
 - Lights when an MP3 track is detected.

- 3 TITLE indicator
 - Lights when the group title or track title is shown on the main display.
- 4 GROUP indicator
 - Lights when the group title or number is shown on the main display.
- 5 TRACK indicator
 - Lights when the track title or number is shown on the main display.
- 6 Main display
- 7 REC indicator
 - Flashes while recording.
- 8 FM reception indicators
 - MONO: lights when monaural reception mode is selected.
 - ST: lights while an FM stereo station with sufficient signal strength is tuned in.
- 9 Disc operation indicators
 - REPEAT: lights when Repeat Play mode is activated.
 - RANDOM: lights when Random Play is activated.
 - ALL 1 DISC:
 - ALL: lights when All Disc Repeat is activated.
 - 1: lights when One Track Repeat is activated.
 - 1 DISC: lights when One Disc Repeat is activated.
 - PROGRAM: lights when Program Play mode is activated.
- 10 Disc indicators
 - Each indicator shows the status of a disc placed on each corresponding disc tray (DISC1 – DISC5).
 - Lights up when a disc is loaded.
 - Goes off when the unit detects there is no disc loaded on the disc tray.
- 11 SURROUND indicator
 - Lights when the surround mode is activated.
- 12 Audio level indicator
- 13 Tape operation indicators
 - ◀▶ (tape direction):
 - Lights to indicate the current tape running direction.
 - Flashes slowly during playback and recording.
 - Flashes quickly while rewinding a tape.
 - Flashes intermittently while locating the beginning of a recording.
 - (Z) (reverse mode):
 - (Z): tape play continues endlessly.
 - Z: tape play stops at the end of one side.
- 14 Timer indicators
 - ⏰: lights when Daily Timer or Recording Timer stands by or is working.
 - SLEEP: flashes when the Sleep Timer is activated.
 - DAILY: lights up when the Daily Timer stands by or is working.
 - REC: lights up when the Recording Timer stands by or is working.

Daily Operations—Playback

In this manual, the operation using the remote control is mainly explained; however, you can use the buttons and controls on the main unit if they have the same (or similar) name and marks.

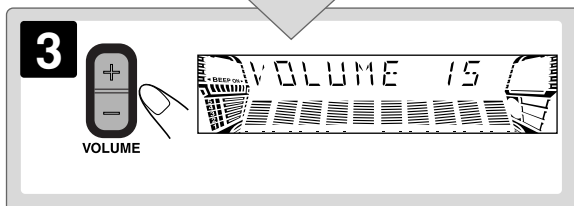
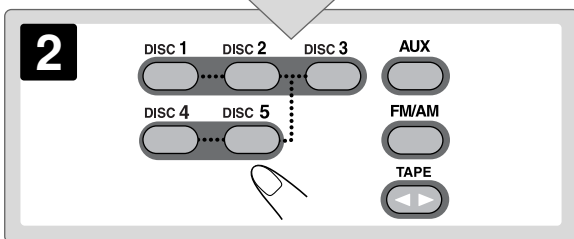
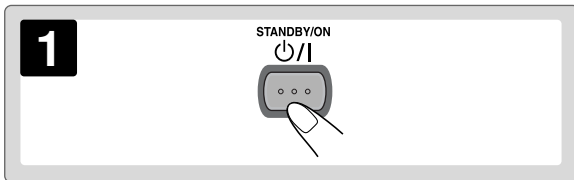
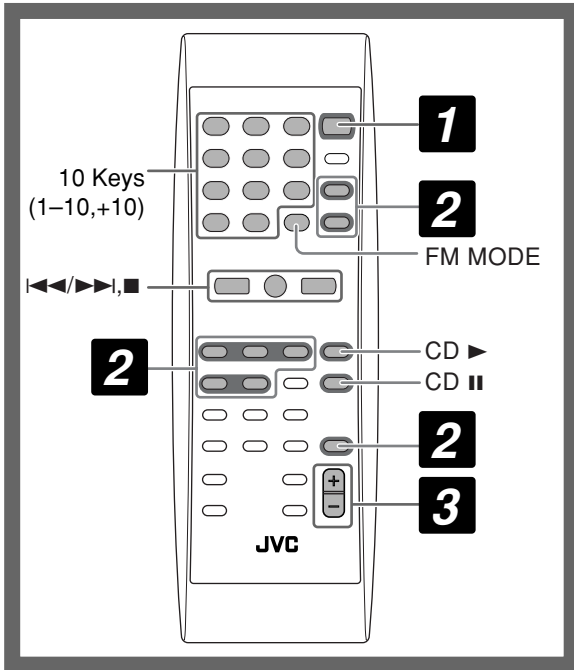

1 Turn on the power.

The STANDBY lamp on the Main unit goes off.

2 Select the source.

Playback automatically starts if the selected source is ready to start.

- If you press AUX, start playback source on the external component.
- Without pressing STANDBY O/I , the System also turn on by pressing one of the source select button in step 2.

3 Adjust the volume.

4 Operate the target source as explained later.

To turn off (stand by) the System

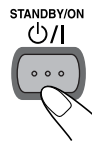

The STANDBY lamp on the unit lights in red.

- A small amount of power is always consumed even while on standby.

For private listening

Connect a pair of headphones to the PHONES jack on the Main unit. The sound will no longer come out of the speakers. Be sure to turn down the volume before connecting or putting the headphones.

- Disconnecting the headphones will activate the speakers again.



DO NOT turn off (stand by) the System with the volume set to an extremely high level; Otherwise, the sudden blast of sound can damage your hearing, speakers and/or headphones when you turn on the System or start playback.

Canceling the Demonstration

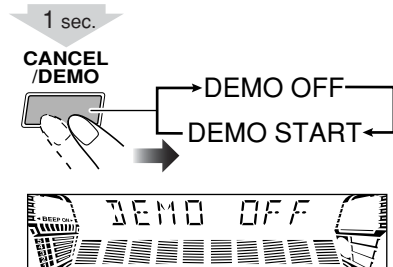

Listening to the Radio

To select the band (FM/AM)

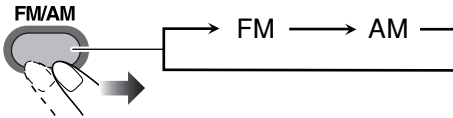

To tune in to a station

While FM or AM are is selected...

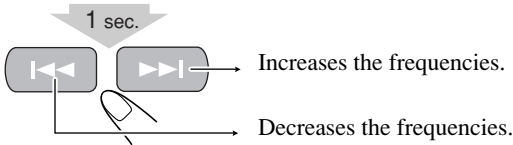

When a station (frequency) with sufficient signal strength is tuned in, the frequency search stops.

To stop searching manually, press either button.

If the received FM station is hard to listen



The MONO indicator lights on the display. Reception will improve though stereo effect is lost—monaural reception mode. To restore the stereo effect, press the button again (the MONO indicator goes off).

To preset Stations



You can preset 30 FM and 15 AM stations.

1 Tune in to a station you want to preset.

2 Enter into the presetting mode.

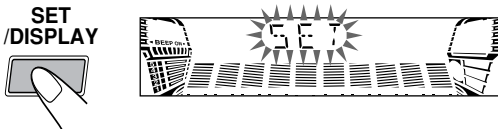

3 Select a preset number for the station you store.

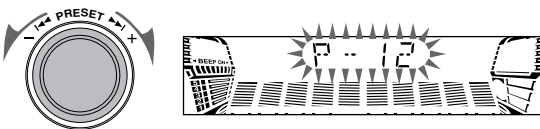

4 Store the station.

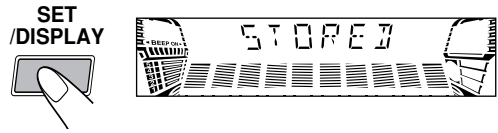

To turn in to a Preset Station

1 Select the band (FM or AM).



2 Select a preset number for the station you store.

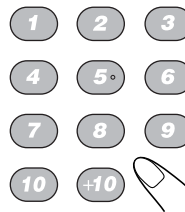

Examples:

To select preset number 5, press 5.

To select preset number 15, press +10, then 5.

To select preset number 30, press +10, +10, then 10.

• You can also use the PRESET +/- control on the unit.

Playing Back a Disc

This System can play back the following discs—regular CD and CD-R/RW (recorded either in the audio CD or MP3 format).

To insert discs

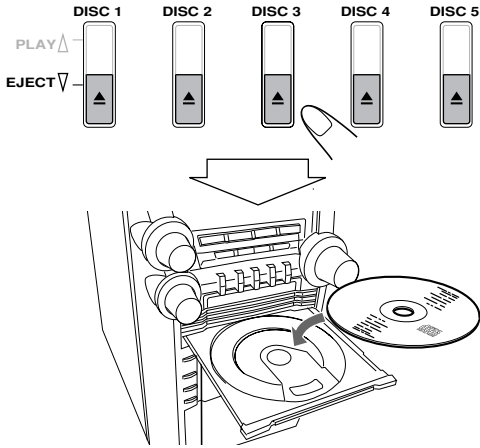

- When using an 8 cm disc, place it on the inner circle of the disc tray.

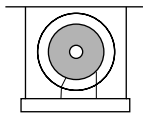

To close the disc tray, press the same ▲ again.

If you press CD ►, disc tray closes automatically and playback starts.

- When you press ▲ for the next tray you want to place another disc onto, the first disc tray automatically closes and then next tray comes out.
- When you load an MP3 disc, you can select a track to start playback. See “To select a track to start playback (MP3 only)” on right column.

To start:	To pause:	To stop:
	 To release it, press CD ►.	

To select a playback disc

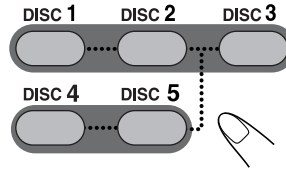

To select a track to start playback (MP3 only)

Before or after playback...

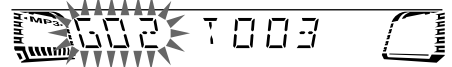

1 Select the group.

Remote control:

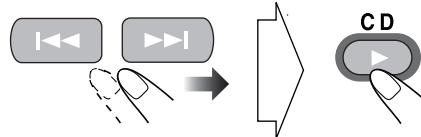

Main unit:

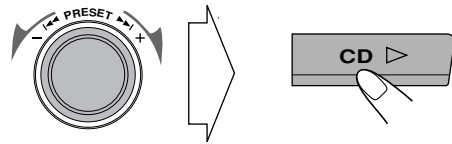

The first track title in that group appears on the display and track number starts blinking.



2 Select a track.

Remote control:

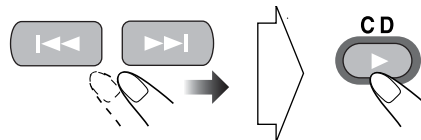

Main unit:

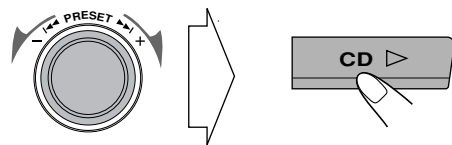

To select a track

While playing a disc...

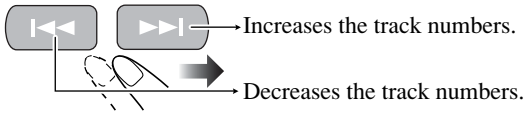

To locate a particular portion

While playing a disc, press and hold the button until the portion you want is reached.

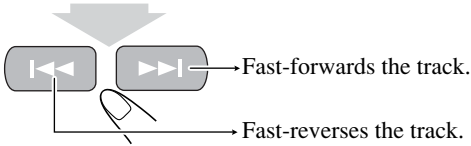

- You can also use on the unit.

To select a track directly

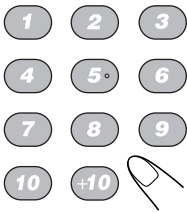

Examples:

To select track 5, press 5.

To select track 15, press +10, then 5.

To select track 30, press +10, +10, then 10.

Playing Back a Tape

To insert a tape

You can play back type I tapes.

- The use of C-120 or longer tape is not recommended.

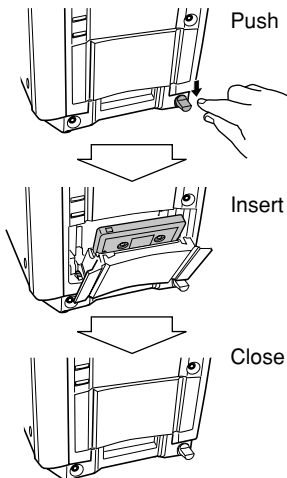

To start:	To stop:
To rewind tape:	
Before or after play...	
	Rewind the tape to the right.
	Rewind the tape to the left.
• You can also use on the unit.	

To change the tape running direction

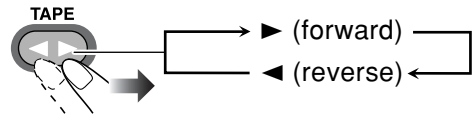

To reverse the tape automatically

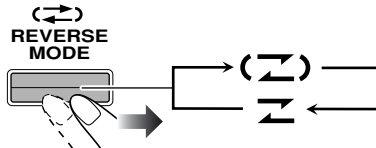

	Tape is automatically reversed, and playback repeats until you stop it.
	Tape will not be reversed. When the current side of the tape reaches its end, playback stops.

To locate the beginning or next of a recording—Music Scan

During play, designate where the recording you want is located—specify how many recordings need to be skipped on the tape.

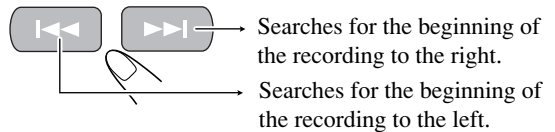

- You can also use on the unit.

Daily Operations—Sound&Other Adjustments

Remote Control

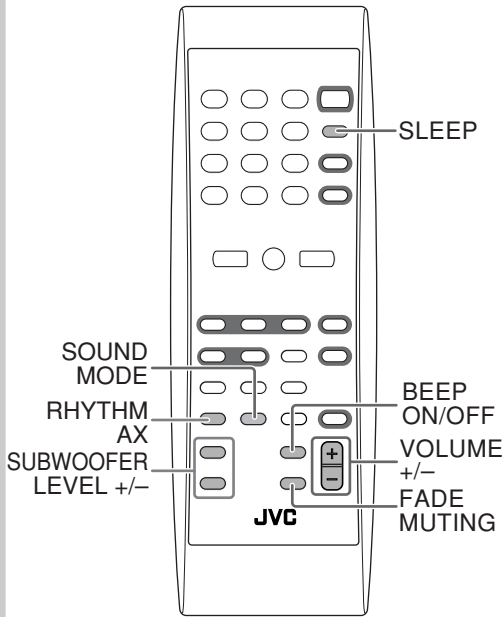

Main unit

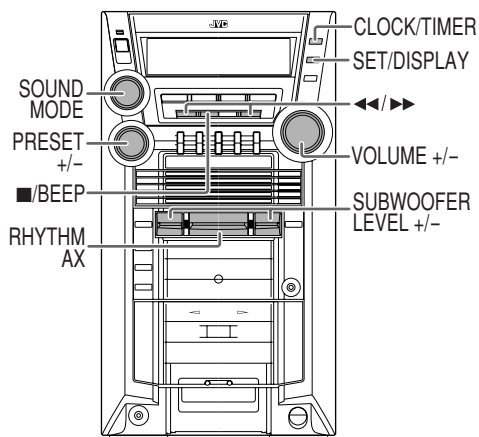

Adjusting the Volume

The volume level can be adjusted in 32 steps (VOLUME MIN, VOLUME 1 – VOLUME 30, VOLUME MAX).

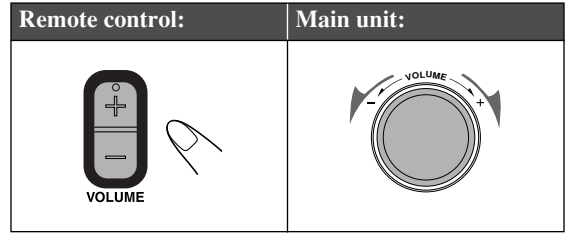

To drop the volume in a moment



To restore the volume, press the button again, or adjust the volume level.



Reinforcing the Bass Sound

To adjust the subwoofer level gradually

You can select the subwoofer level from level 0 (minimum) to level 2 (maximum).

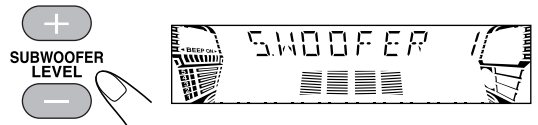

To emphasize rhythm feeling—RHYTHM AX

This function emphasizes bass attack feeling, and also changes the subwoofer level.

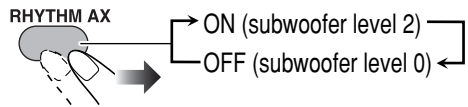

Selecting the Sound Modes

You can select one of the preset Sound Modes.

Remote control:

Main unit:

Surround modes*	
DANCE	Increases resonance and bass.
HALL	Adds depth and brilliance to the sound.
STADIUM	Adds clarity and spreads the sound, as in an outdoor stadium.
SEA (Sound Effect Amplifier) modes	
ROCK	Boosts low and high frequency. Good for acoustic music.
POP	Good for vocal music.
CLASSIC	Good for classical music.
User modes	
USER 1/2/3	Your individual mode stored in memory. See the next column "Creating Your Own Sound Modes—User Mode."
OFF	No Sound Mode effect (FLAT).

* Surround elements are added to the SEA elements to create being-there feeling in your room.

Creating Your Own Sound Modes

—User Mode



You can create your own Sound Modes to make sounds suit your taste. The changed settings can be stored as the USER 1, USER 2 and USER 3 modes.

1 Select one of the preset Sound Modes.

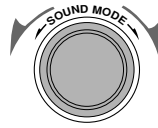

- If you want to add surround elements into your Sound Mode, select one of the surround modes.

2 Enter into the SEA Control Mode.

- You can enter the SEA Control Mode only while the Sound Mode appears on the display.

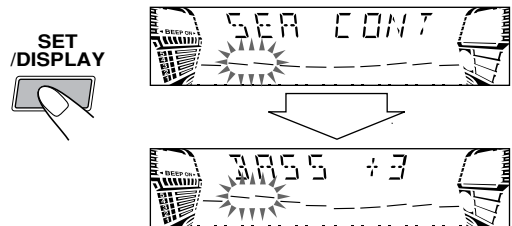

3 Adjust the SEA pattern.

- ① Select one of the tone—BASS or TRE.



- ② Adjust the level of the selected tone.

- You can adjust the bass and treble level from -3 to +3.

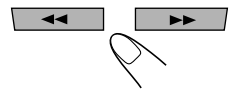

- ③ Repeat steps ① and ② to adjust the level of the other tone.

- ④ Finish the SEA pattern setting.



4 Select one of the User Modes in which you want to store your adjustment.

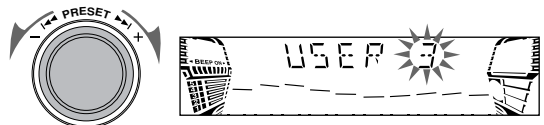

5 Finish the setting.

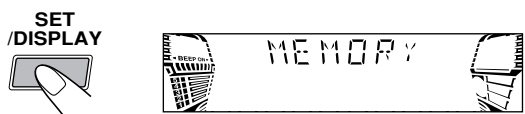

Turning On or Off the Key-Touch Tone

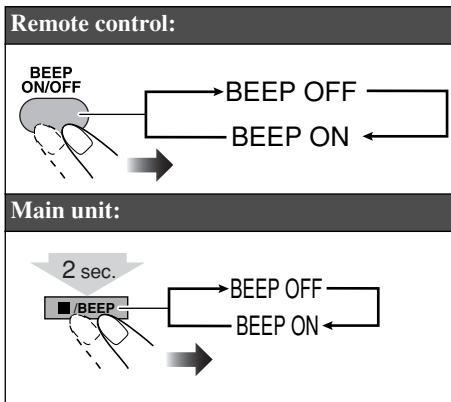

Setting the Clock



Without setting the built-in clock, you cannot use Daily/Recording Timers (see page 20) and Sleep Timer.

- To exit from the clock setting, press **CLOCK/TIMER** as required.
- To go back to the previous step, press **CANCEL/DEMO**.

1 Enter into clock setting mode.

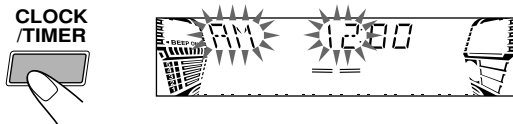

- If you have already adjusted the clock before, press the button repeatedly until the clock setting mode is selected.

2 Adjust the hour.

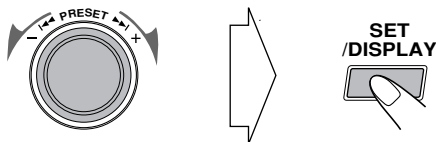

3 Adjust the minute.

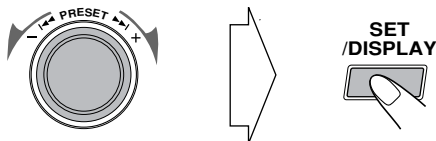

Now the built-in clock starts working.

To check the current time during play

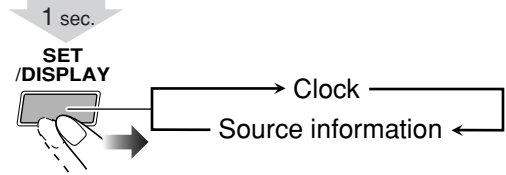

Turning Off the Power Automatically



With Sleep Timer, you can fall asleep to music. You can set Sleep Timer only while the System is turned on.

1 You can specify the time (in minutes) as you like.

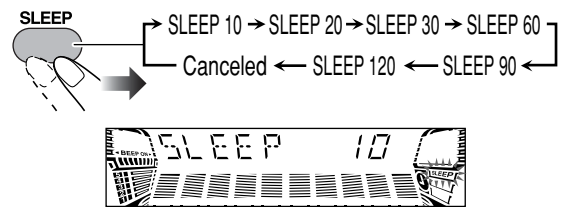

2 Wait until the set time goes off.

To check the time remaining until the shut-off time

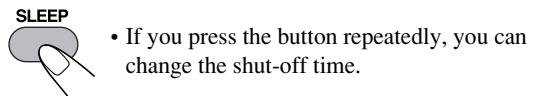

Advanced Disc Operations

Remote Control

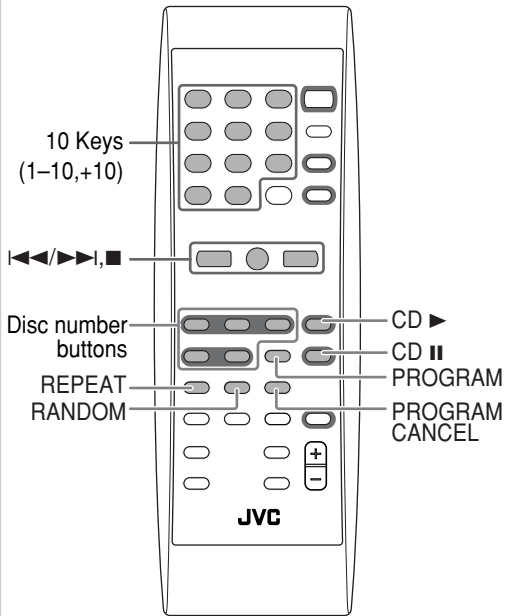

Main unit

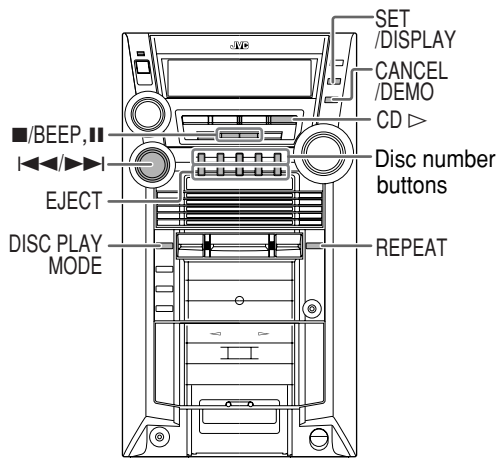

Programming the Playing Order

—Program Play

You can arrange the playing order of the tracks (up to 100) before you start playback.

1 Before starting playback, activate Program Play.

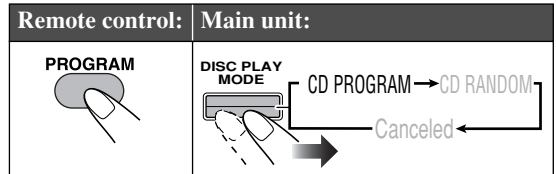

2 Select a disc.

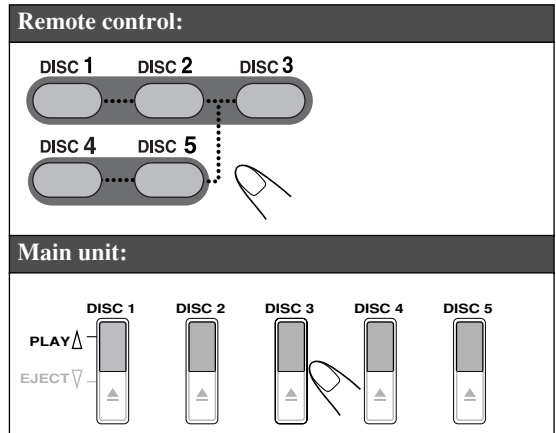

3 Select tracks you want for Program Play.

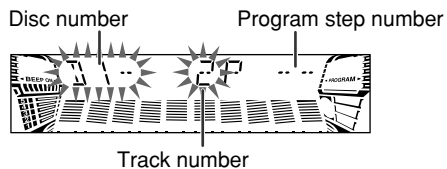

Remote control:

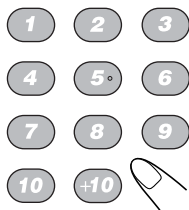

Examples:

- To select track 5, press 5.
- To select track 15, press +10, then 5.
- To select track 30, press +10, +10, then 10.

Main unit:

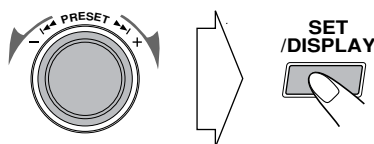

- When making programs from MP3 discs, the unit only recognizes tracks like audio CD. You cannot make programs using group numbers.

4 Repeat steps 2 and 3 until you program all tracks you want.

5 Start playback.



The tracks you have selected are played back in the order you have programmed.

To skip a track:	To pause:	To stop:
	To release, press CD ▶.	

To check the programmed contents

Before or after playback...

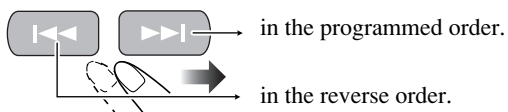

To modify the program

Before or after playback...

To erase the last step:	To erase the entire program:
<ul style="list-style-type: none"> You can also use CANCEL/DEMO on the unit. 	
To add steps in the program	
Repeat steps 2 and 3 on page 15.	

To exit from Program Play

Before or after playback...

Remote control:	Main unit:

Playing at Random—Random Play

You can play the contents of all loaded discs at random.

1 Before starting playback, activate Random Play.

Remote control:	Main unit:

2 Start playback.



Playback starts in a random order. Random Play ends when all the contents of all loaded discs are played.

To skip:	To pause:	To stop:
◀◀ does not work.	To release it, press CD ▶.	

To exit from Random Play

Before or after playback...

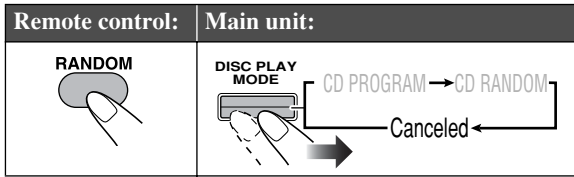

Repeating Playback—Repeat Play

You can repeat playback.

While playing or before starting playback...

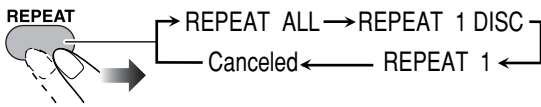

Repeat mode indicators

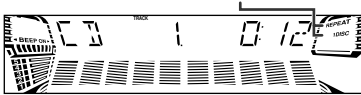

REPEAT ALL	Repeats all tracks on all loaded discs.
REPEAT 1 DISC	Repeats all tracks on the current disc.
REPEAT 1	Repeats the current (or specified) track.

- “REPEAT 1 DISC” cannot be selected for Program Play or Random Play. It is also canceled when you select Program Play or Random Play.

Prohibiting Disc Ejection—Tray Lock

You can prohibit disc ejection from the System and lock discs.

- This operation is possible only when the source is the CD player.

While the disc tray is closed...

Press **▲** for any disc tray while holding down **■/BEEP**.

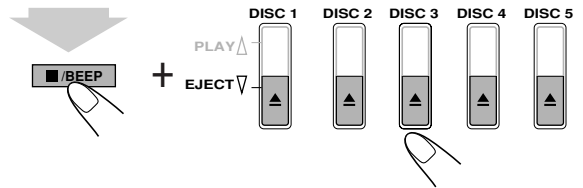

- If you try to eject discs while Tray Lock is in use, “LOCKED” appears to inform you that the disc trays are locked.

To cancel the prohibition, repeat the same procedure. “UNLOCKED” appears on the display.

Advanced Tape Operations

Remote control

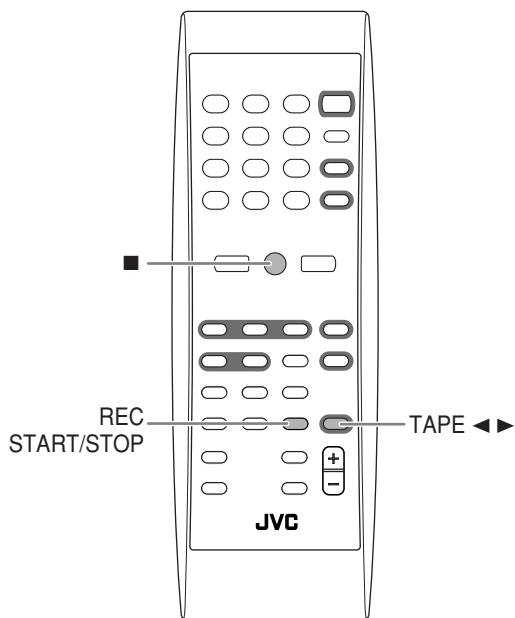

Main unit

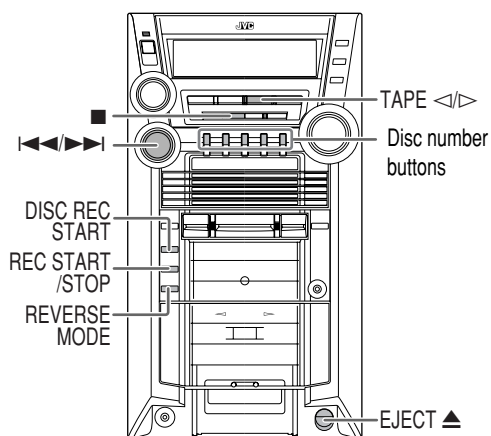

IMPORTANT

It should be noted that it may be unlawful to re-record pre-recorded tapes, records, or discs without the consent of the owner of copyright in the sound or video recording, broadcast or cable programme and in any literary, dramatic, musical, or artistic embodied therein.

Recording on a Tape

You can use type I tapes for recording.

- To play a tape, see page 11.

1 Insert a recordable cassette.

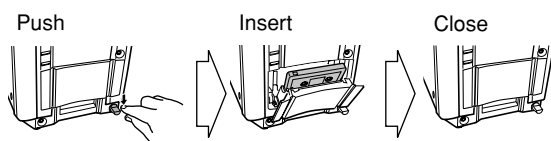

2 Check the tape direction of the cassette deck on the display.

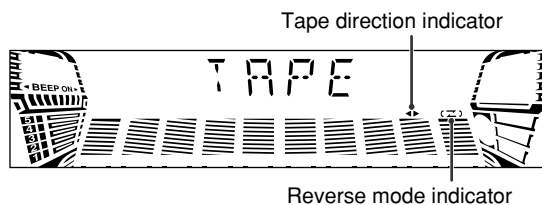

To change the direction

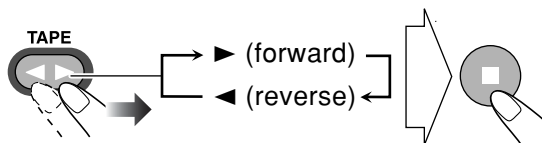

To change the Reverse mode if necessary

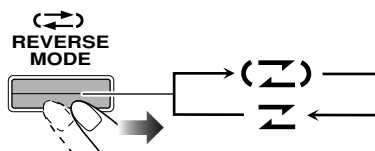

(↔)	To record on both sides. • When using Reverse Mode, start recording in the forward (▶) direction.
↔	To record on only one side.

3 Start playing the source—FM, AM, or CD player, or auxiliary equipment connected to AUX jacks.

- When recording a disc, you can also use “Synchronized Disc Recording” (see below).

4 Start recording.



To stop recording



Synchronized Disc Recording



You can start and stop both disc play and tape recording at the same time.

1 Load a disc and insert a recordable cassette.

2 Select a disc.

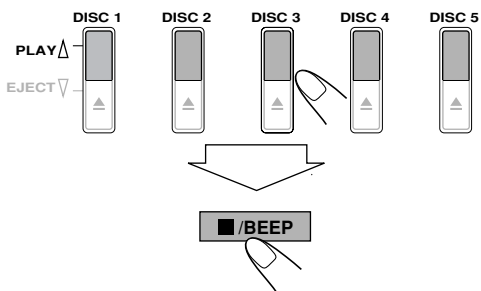

- When you record an MP3 disc, you can select a track to start recording with (see “To select a track to start playback (MP3 only)” on page 10).

For recording desired tracks on discs:

You can program tracks to record from plural discs with your preferred order.

- Select Program Play (and make a program (see page 15)) without starting playback.

3 Change the Reverse mode if necessary (see page 18).

4 Start recording.

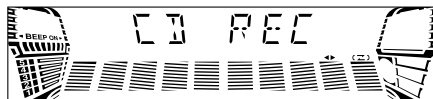

- When either CD play or recording ends, both CD player and the cassette deck stop at the same time.

To protect your recording

Cassettes have two small tabs on the back to protect from unexpected erasure or re-recording.

To protect your recording, remove these tabs.



To re-record on a protected tape, cover the holes with adhesive tape.

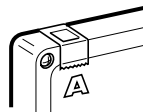

Timer Operations

Main unit

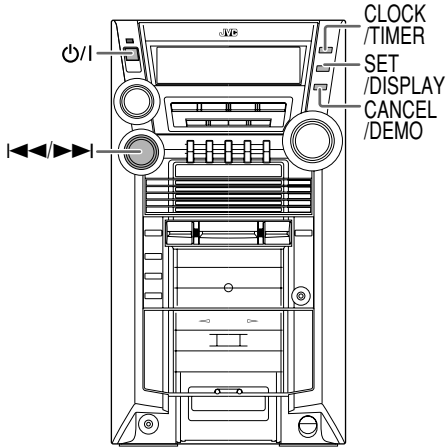

Setting the Timer



Using Daily Timer, you can wake up with your favorite song. On the other hand, with Recording Timer, you can make a tape of a radio broadcast automatically.

- To correct a misentry during the process, press CANCEL/DEMO. You can return to the previous step.

1 Select one of the timer setting modes (TIMER(ON)) you want to set—Daily Timer or Recording Timer.

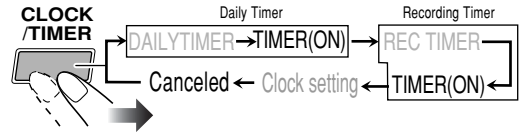

Ex.: When Daily timer setting mode is selected.

2 Make the timer setting as you want.

Repeat the procedure until you finish setting in the following order:

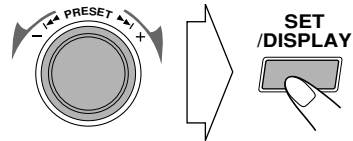

- ① Set the hour then minute for on-time.
- ② Set the hour then minute for off-time.
- ③ For Daily Timers: Select the playback source—“TUNER-FM,” “TUNER-AM,” “CD,” “TAPE” or “AUX IN.”

For Recording Timer: Select the playback source—“TUNER-FM” or “TUNER-AM.”

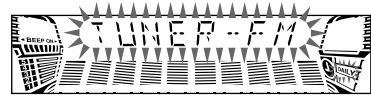

Ex.: When “TUNER-FM” is selected.

- ④ Select a preset station for “TUNER-FM” and “TUNER-AM,” or select a disc and track number for “CD.”

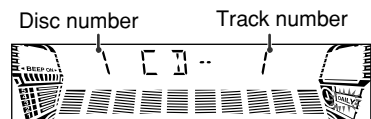

Ex.: When “CD” is selected.



- ⑤ **For Daily Timers: Select the volume level**
- You can select the volume level (“VOLUME 5,” “VOLUME 10,” “VOLUME 15” and “VOLUME --”). If you select “VOLUME --,” the volume is set to the last level when the System has been turned off.

3 Turn off the System (on standby) if you have set the timer with the System turned on.



How Daily Timer actually works

Once the Daily Timer has been set, the timer (🕒) indicator and DAILY indicator are lit on the display. Daily Timer is activated at the same time everyday until the timer is turned off manually (see the next column).

When the on-time comes

The System turns on, tunes in to the specified station or start playing the specified source, and sets the volume level to the preset level.

When the off-time comes

The System stops playback, and turns off (stands by).

- The timer setting remains in memory until you change it.

How Recording Timer actually works

When Recording Timer has been set, Timer (🕒) indicator and the REC indicator are lit on the display. Recording Timer works only once.

When the on-time comes

The System turns on, tunes in to the specified station, sets the volume level to “VOLUME MIN,” and starts recording.

When the off-time comes

The System stops recording, and turns off (stands by).

- The timer setting remains in memory until you change it.

To turn off the Timer after its setting is done

You can turn off the timer after it has been set.

- Since Daily Timer is activated at the same time everyday, you may need to cancel it on some particular days.

1 Select the timer (DAILYTIMER or REC TIMER) you want to cancel.

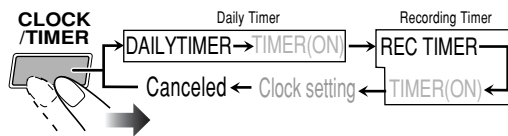

2 Turn off the selected timer.



- The timer (🕒) indicator goes off.

To turn on the timer again, repeat the step 1 and press SET/DISPLAY in step 2.



Timer Priority

Since each timer can be set separately, you may wonder what happens if the setting for these timers overlaps.

- Recording Timer has priority over the Daily Timer and Sleep Timer (see page 14).

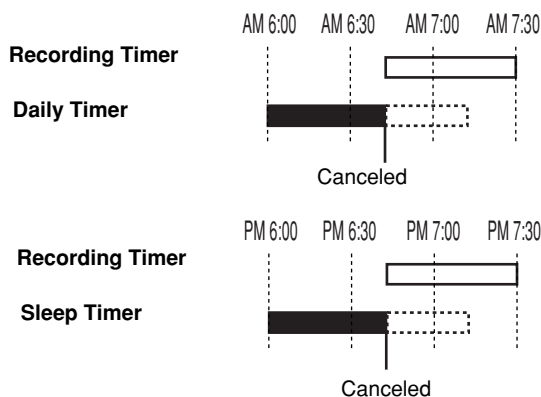

Additional Information

Learning More about This System ● ● ●

Daily Operations—Playback (see pages 8 to 11)

Listening to the Radio:

- When you repeatedly press ►►1 / ◀◀◀ (TUNING +/- on the unit), the frequency changes step by step.
- If you store a new station into an occupied preset number, the previously stored station in that number will be erased.
- When you unplug the AC power cord or if a power failure occurs, the preset stations will be erased in a few days. If this happens, preset the station again.

Playing Back a Disc:

- This System cannot play “packet write” discs.
- For MP3 playback...
 - MP3 discs are required a longer readout time than regular CDs. (It depends on the complexity of the group/file configuration.)
 - Some MP3 files cannot be played back and will be skipped. This result from their recording processes and conditions.
 - When making MP3 discs, use ISO 9660 Level 1 or level 2 for disc format.
 - This System can play back MP3 files with the extension code <.mp3> (regardless of the letter case—upper or lower).
 - It is recommended that you make each MP3 files at a sampling rate of 44.1 kHz and at bit rate of less than 64 kbps.
 - This System manages files and folders as “tracks” and “groups.”
 - This System can recognize up to 255 groups per disc (up to 999 tracks).
- When discs* in more than one tray are loaded on the disc trays, they are played in sequence as follows:

Ex.: When DISC 2 is pressed:

DISC 2⇒DISC 3⇒DISC 4⇒DISC 5⇒DISC 1
(then stops)

- * When no disc is loaded on the tray, that disc number is skipped.
- You can exchange discs while playing or selecting another disc.
- If the MP3 file has ID3 Tags, the disc information (track title, performer name and album name) will be shown after the file name appears.

Playing Back a Tape:

- Music Scan works by detecting a 4-second long blank between each tunes, so it will not work well in the following cases:
 - No blank at the beginning of a tunes.
 - Noise (often caused by much use or poor quality dubbing) which fills the blank.
 - Long, very soft passages or pauses in a tunes.

Daily Operations—Sound&Other Adjustments (see pages 12 to 14)

Adjusting the Volume:

- Be sure to turn down the volume before connecting or putting the headphones.

Adjusting the Sound:

- This function also affects the sound through the headphones.
- While listening with the headphones, you cannot adjust the subwoofer level.

- This function does not affect recording.
- You can adjust the subwoofer level while RHYTHM AX is on.
- The subwoofer lamp changes brightness according to the subwoofer level.

Selecting the Sound Modes:

- The sound mode lamp and Surround mode lamp change brightness according to selecting sound mode.

Creating Your Own Sound Modes—User Mode:

- When you unplug the AC power cord or if a power failure occurs, the setting will be erased in a few days. If this happens, set the user modes again.

Setting the clock:

“AM 12:00” will flash on the display until you set the clock.

Turning Off the Power Automatically:

- If you turn off the System, Sleep Timer is canceled.

Advanced Disc Operations (see pages 15 to 17)

Programming the Playing Order—Program Play:

- While programming steps...
 - If you try to program a disc number which tray is not loaded, “NO READ” appears on the display and your entry will be ignored.
 - Your entry will be ignored if you have tried to program an item number that does not exist on the disc (for example, selecting track 14 on a disc that only has 12 tracks). Such entries are ignored, and are erased from the program.

Advanced Tape Operations (see pages 18 and 19)

Recording on a Tape:

- The recording level is automatically set correctly. Thus, you can adjust the sound (volume, sound mode, RHYTHM AX and subwoofer level) you are actually listening to without affecting the recording level during recording.
- There is leader tape which cannot be recorded onto at the start and end of cassette tapes. Thus, when recording CDs or radio broadcasts, wind the leader tape first to ensure that the recording will be made without any music part lost.
- If no cassette is inserted, “NO TAPE” appears on the display. If a protected tape has been inserted, “NO REC” appears on the display.
- When using Reverse Mode for recording, start recording in the forward (►) direction first; otherwise, recording will stop when only one side (reverse) of the tape is recorded.
- You cannot change the source while recording. If you want to change the source, stop recording.

Synchronized Disc Recording:

- Everything on the disc goes onto the tape in the order on the disc, or according to the order you have made for Program Play.
- When recording starts, “CD REC” appears on the display and the REC (recording) indicator flashes.
- When the tape reaches its end in the forward direction (►) during recording, the last song will be re-recorded at the beginning of the reverse side (◄).
- When the tape reaches its end in the reverse side (◄) during recording, recording stops even though the entire disc is not entirely recorded.

Timer Operations (see pages 20 and 21)

- When you unplug the AC power cord or if a power failure occurs, the timer will be canceled. You need to set the clock first, then the timer again.
- Without stopping the recording, you cannot change the source after Recording Timer starts recording.
- If you set the Sleep Timer after Daily Timer starts playing the selected source, Daily Timer is canceled.
- If Sleep Timer is set to come on while Recording timer is operating, Sleep Timer will not come on at all.

Maintenance

To get the best performance of the System, keep your discs, tapes, and mechanism clean.

Handling discs

- Remove the disc from its case by holding it at the edge while pressing the center hole lightly.
- Do not touch the shiny surface of the disc, or bend the disc.
- Put the disc back in its case after use to prevent warping.
- Be careful not to scratch the surface of the disc when placing it back in its case.
- Avoid exposure to direct sunlight, temperature extremes, and moisture.

To clean the disc:

Wipe the disc with a soft cloth in a straight line from center to edge.

Handling cassette tapes

- If the tape is loose in its cassette, take up the slack by inserting a pencil in one of the reels and rotating.
- If the tape is loose, it may get stretched, cut, or caught in the cassette.
- Be careful not to touch the tape surface.
- Avoid the following places to store the tape—in dusty places, in direct sunlight or heat, in moist areas, on a TV or speaker, or near a magnet.

To keep the best recording and playback sound quality:

- Use a cotton swab moistened with alcohol to clean the heads, capstans, and pinch rollers.
- Use a head demagnetizer (available at electronics and audio shops) to demagnetize the heads (when the System turned off).

Cleaning the System

- Stains should be wiped off with a soft cloth. If the System is heavily stained, wipe it with a cloth soaked in water-diluted neutral detergent and wrung well, then wipe clean with a dry cloth.
- Since the System may deteriorate in quality, it become damaged or get its paint peeled off, be careful about the following:
 - DO NOT wipe it with a hard cloth.
 - DO NOT wipe it strong.
 - DO NOT wipe it with thinner or benzine.
 - DO NOT apply any volatile substance such as insecticides to it.

DO NOT allow any rubber or plastic to remain in contact with it for a long time.

Troubleshooting

If you are having a problem with your System, check this list for a possible solution before calling for service.

General:

Adjustments or settings are suddenly canceled before you finish.

⇒ There is a time limit. Repeat the procedure again.

Operations are disabled.

⇒ The built-in microprocessor may malfunction due to external electrical interference. Unplug the AC power cord and then plug it back in.

Unable to operate the System from the remote control.

⇒ The path between the remote control and the remote sensor on the System is blocked. Remove the obstruction.

⇒ The batteries are exhausted.

No sound is heard.

⇒ Speaker connections are incorrect or loose (see pages 4 and 5).

⇒ Headphones are connected. Disconnect the headphones.

Radio Operations:

Hard to listen to broadcasts because of noise.

⇒ Antennas connections are incorrect or loose (see pages 4 and 5).

⇒ The AM loop antenna is too close to the System.

⇒ The FM antenna is not properly extended and positioned.

Disc Operations:

The disc does not play.

⇒ The disc is placed upside down. Place the disc with the label side up.

The disc sound is discontinuous.

⇒ The disc is scratched or dirty.

The disc tray does not open or close.

⇒ The AC power cord is not plugged in.

⇒ Tray Lock is in use (see page 17).

Tape Operations:

The cassette holder cannot be opened.

⇒ Power supply from the AC power cord has been cut off while the tape was running. Turn on the System.

Recordings:

Impossible to record.

⇒ Small tabs on the back of the cassette are removed. Cover the holes with adhesive tape.

Timer operations:

Daily Timer and Recording Timer do not work.

⇒ The System has been turned on when the on-time comes. Timer starts working only when the System is turned off.

Specifications

Amplifier section—CA-HXGX7

Output Power:

SUBWOOFERS: 180 W per channel, min. RMS, driven into 6 Ω at 63 Hz with no more than 10 % total harmonic distortion.

MAIN SPEAKERS: 80 W per channel, min. RMS, driven into 6 Ω at 1 kHz with no more than 10 % total harmonic distortion.

Audio input sensitivity/impedance

(Measured at 1 kHz, with tape recording signal 300 mV)

AUX: 300 mV/47 k Ω

Speakers/impedance:

SUBWOOFERS: 6 Ω – 16 Ω

MAIN SPEAKERS: 6 Ω – 16 Ω

Tuner

FM tuning range: 87.5 MHz – 108.0 MHz

AM tuning range: 530 kHz – 1 710 kHz

CD player

CD capacity: 5 discs

Dynamic range: 87 dB

Signal-to-noise ratio: 90 dB

Wow and flutter: Immeasurable

MP3 recording format: MPEG 1/2 Audio Layer 3

Max. Bit rate: 320 kbps

Cassette deck

Frequency response

Normal (type I): 50 Hz – 14 000 Hz

Wow and flutter: 0.15 % (WRMS)

General

Power requirement: AC 120 V \sim , 60 Hz

Power consumption: 245 W/310 VA (at operation)

26 W (on standby)

Dimensions (approx.): 205 mm x 370 mm x 432 mm

(W/H/D)

(8 $\frac{1}{8}$ in. x 14 $\frac{5}{8}$ in. x 17 $\frac{1}{16}$ in.)

Mass (approx.): 10.5 kg (23.2 lbs)

Supplied Accessories

See page 3.

Speaker section—SP-HXGX7

Type: 3-Way 4-Speaker Bass-Reflex Type

Speaker Systems:

Subwoofer: 16 cm (6 $\frac{5}{16}$ in.) cone x 1

Woofers: 12 cm (4 $\frac{3}{4}$ in.) cone x 2

Tweeter: 5 cm (2 in.) cone x 1

Power handling capacity:

Subwoofer: 360 (180 + 180) W

Main speaker: 160 (80 + 80) W

Impedance:

Subwoofer: 6 Ω

Main speaker: 6 Ω

Frequency range:

Subwoofer: 27 Hz – 1000 Hz

Main speaker: 70 Hz – 25 000 Hz

Sound pressure level:

Subwoofer: 78 dB/W \cdot m

Main speaker: 88 dB/W \cdot m

Dimensions (approx.): 227 mm x 432 mm x 376 mm

(W/H/D)

(8 $\frac{15}{16}$ in. x 17 $\frac{1}{16}$ in. x 14 $\frac{13}{16}$ in.)

Mass (approx.): 8 kg (17.7 lbs) each

Design and specifications are subject to change without notice.



LIMITED WARRANTY

AUDIO-1

JVC COMPANY OF AMERICA warrants this product and all parts thereof, except as set forth below ONLY TO THE ORIGINAL PURCHASER AT RETAIL to be FREE FROM DEFECTIVE MATERIALS AND WORKMANSHIP from the date of original retail purchase for the period as shown below. ("The Warranty Period")

PARTS	1 YR	LABOR	1 YR
-------	-------------	-------	-------------

THIS LIMITED WARRANTY IS VALID ONLY IN THE FIFTY (50) UNITED STATES, THE DISTRICT OF COLUMBIA AND IN COMMONWEALTH OF PUERTO RICO.

WHAT WE WILL DO:

If this product is found to be defective, JVC will repair or replace defective parts at no charge to the original owner. Such repair and replacement services shall be rendered by JVC during normal business hours at JVC authorized service centers. Parts used for replacement are warranted only for the remainder of the Warranty Period. All products and parts thereof may be brought to a JVC authorized service center on a carry-in basis except for Television sets having a screen size 25 inches and above which are covered on an in-home basis.

WHAT YOU MUST DO FOR WARRANTY SERVICE:

Return your product to a JVC authorized service center with a copy of your bill of sale. For your nearest JVC authorized service center, please call toll free: (800) 537-5722.

If service is not available locally, box the product carefully, preferably in the original carton, and ship, insured, with a copy of your bill of sale plus a letter of explanation of the problem to the nearest JVC Factory Service Center, the name and location of which will be given to you by the toll-free number.

If you have any questions concerning your JVC Product, please contact our Customer Relations Department.

WHAT IS NOT COVERED:

This limited warranty provided by JVC does not cover:

1. Products which have been subject to abuse, accident, alteration, modification, tampering, negligence, misuse, faulty installation, lack of reasonable care, or if repaired or serviced by anyone other than a service facility authorized by JVC to render such service, or if affixed to any attachment not provided with the products, or if the model number or serial number has been altered, tampered with, defaced or removed;
2. Initial installation and installation and removal for repair;
3. Operational adjustments covered in the Owner's Manual, normal maintenance, video and audio head cleaning;
4. Damage that occurs in shipment, due to act of God, and cosmetic damage;
5. Signal reception problems and failures due to line power surge;
6. Video Pick-up Tubes/CCD Image Sensor, Cartridge, Stylus (Needle) are covered for 90 days from the date of purchase;
7. Accessories
8. Batteries (except that Rechargeable Batteries are covered for 90 days from the date of purchase);

There are no express warranties except as listed above.

THE DURATION OF ANY IMPLIED WARRANTIES, INCLUDING THE IMPLIED WARRANTY OF MERCHANTABILITY, IS LIMITED TO THE DURATION OF THE EXPRESS WARRANTY HEREIN.

JVC SHALL NOT BE LIABLE FOR THE LOSS OF USE OF THE PRODUCT, INCONVENIENCE, LOSS OR ANY OTHER DAMAGES, WHETHER DIRECT, INCIDENTAL OR CONSEQUENTIAL (INCLUDING, WITHOUT LIMITATION, DAMAGE TO TAPES, RECORDS OR DISCS) RESULTING FROM THE USE OF THIS PRODUCT, OR ARISING OUT OF ANY BREACH OF THIS WARRANTY. ALL EXPRESS AND IMPLIED WARRANTIES, INCLUDING THE WARRANTIES OF MERCHANTABILITY AND FITNESS FOR PARTICULAR PURPOSE, ARE LIMITED TO THE WARRANTY PERIOD SET FORTH ABOVE.

Some states do not allow the exclusion of incidental or consequential damages or limitations on how long an implied warranty lasts, so these limitations or exclusions may not apply to you. This warranty gives you specific legal rights and you may also have other rights which vary from state to state.

JVC COMPANY OF AMERICA 1700 Valley Road
 DIVISION OF JVC AMERICAS CORP. Wayne, NJ 07470

REFURBISHED PRODUCTS CARRY A SEPARATE WARRANTY, THIS WARRANTY DOES NOT APPLY. FOR DETAILS OF REFURBISHED PRODUCT WARRANTY, PLEASE REFER TO THE REFURBISHED PRODUCT WARRANTY INFORMATION PACKAGED WITH EACH REFURBISHED PRODUCT.

For customer use:

Enter below the Model No. which is located either on the rear, bottom or side of the cabinet. Retain this information for future reference.

Model No. : _____

Serial No. : _____

Purchase data : _____

Name of dealer : _____

Authorized Service Centers

QUALITY **JVC**[®] SERVICE

HOW TO LOCATE YOUR JVC SERVICE CENTER

TOLL FREE: 1 (800) 537-5722

<http://www.jvc.com>

Dear Customer,

In order to receive the most satisfaction from your purchase, please read the instruction booklet before operating the unit. In the event that repairs are necessary, please call 1 (800)537-5722 for your nearest authorized servicer or visit our website at **www.JVC.com**

Remember to retain your Bill of Sale for Warranty Service.

Do not service the television yourself

Caution

To prevent electrical shock, do not open the cabinet. There are no user serviceable parts inside. Please refer to qualified service personnel for repairs.

Accessories

To purchase accessories for your JVC product, please call toll free: 1 (800)882-2345 or on the web at **www.JVC.com**

HX-GX7

COMPACT COMPONENT SYSTEM

JVC
VICTOR COMPANY OF JAPAN, LIMITED

